

STAINLESS STEEL

CABLE CONTAINMENT SYSTEMS



STRUT CHANNEL

RIGID CONDUIT

CABLE TRUNKING

CABLE LADDER

CABLE TRAY

FITTINGS



2022 Edition 1.0

SMART^{Tr}

Your Trusted Partner in
Electrical & Mechanical Support

INTRODUCTION TO **SMARTr**[®]

Our extended portfolio now includes stainless steel conduit, metal framing (struts), cable trunking, cable tray, cable ladder and all related fittings to meet the global industry's standards. This includes medium and heavy duty-applications that are used in support of equipment for Electrical, Mechanical, Plumbing, HVAC, covering Data Centers, new and retrofit commercial, projects including industrial sewage treatment installations.



CONTACT US

SMARTr Marketing Pte. Ltd.
66 Kian Teck Road
Singapore 628796
Email
Tel
Fax

enquiry@smartr.com.sg
+65 6273 6606
+65 6271 6606

**YOUR TRUSTED
SPECIALIST
SUPPLIER IN
STAINLESS STEEL
CABLE CONTAINMENT**



CONDUIT & FITTINGS

BENEFITS OF SS CONDUITS

DURABLE LONG LASTING

CORROSION RESISTANT

WATER-PROOF CONDUIT BODY

FAST AND CLEAN INSTALLATION

Conduit Systems for Cable Management.
 Certified to BS EN Standards:
 BS EN 61386, Conduit Systems for Cable Management
 Part 1: General Requirements
 Part 21: Particular Requirements - Rigid Conduit Systems
 Part 25: Particular Requirements - Conduits Fixing Devices



CONDUIT

SPECIFICATIONS

STANDARD	BS EN 61386 PART 1/21/25
MATERIAL	304/316 STAINLESS STEEL
MATERIAL THICKNESS	20M/25MM- 1.5MM
THREAD	ISO FORM 1.5MM PITCH
LENGTH	3.0MTR/LGTH

DESCRIPTION

PART CODE

20MM SS316 CONDUIT 3MTR	CP-20-SS-SMTR
25MM SS316 CONDUIT 3MTR	CP-25-SS-SMTR
20MM SS 1 WAY BOX	CF-20-1W-SS-SMTR
20MM SS 2 WAY BOX	CF-20-2W-SS-SMTR
20MM SS ANGLE BOX	CF-20-A-SS-SMTR
20MM SS 3 WAY BOX	CF-20-3W-SS-SMTR
20MM SS 4 WAY BOX	CF-20-4W-SS-SMTR
20MM SS SOCKET (COUPLER)	CF-20-S-SS
20MM SS SADDLES	CF-20-SB-SS
20MM DISTANCE SADDLES	CF-20-DS-SS-SMTR
25MM SS 1 WAY BOX	CF-25-1W-SS-SMTR
25MM SS 2 WAY BOX	CF-25-2W-SS-SMTR
25MM SS ANGLE BOX	CF-25-A-SS-SMTR
25MM SS 3 WAY BOX	CF-25-3W-SS-SMTR
25MM SS 4 WAY BOX	CF-25-4W-SS-SMTR
25MM SS SOCKET (COUPLER)	CF-25-S-SS
25MM SS SADDLES	CF-25-SB-SS
25MM SS DISTANCE SADDLES	CF-25-DS-SS-SMTR

*Other sizes available upon request
 All conduit boxes manufactured to IP67,
 are supplied with a cover, gasket and screws.
 *SS Flexible Conduit/Adaptors and other
 accessories not shown above are
 also available upon request.

*Adaptable boxes supplied w/o Knock-Out (KO)
 holes. KO holes if required need to be specially
 ordered according to needs.

STRAIGHT CABLE TRUNKING

STANDARD COMPLY TO
BS EN 50085 - 1

PRODUCT STANDARD LIST

WIDTH (W)	HEIGHT (H)	LENGTH (L)	THICKNESS (T)
50	25-50	2440-3000*	0.8-1.5
75	50-75	2440-3000*	0.8-1.5
100	50-100	2440-3000*	0.8-1.5
150	50-100	2440-3000*	0.8-1.5
200	100	2440-3000*	0.8-1.5
250	100	2440-3000*	0.8-1.5
300	100	2440-3000*	0.8-1.5
450	100	2440-3000*	1.5-2.0
600	100	2440-3000*	1.5-2.0
700	100	2440-3000*	1.5-2.0

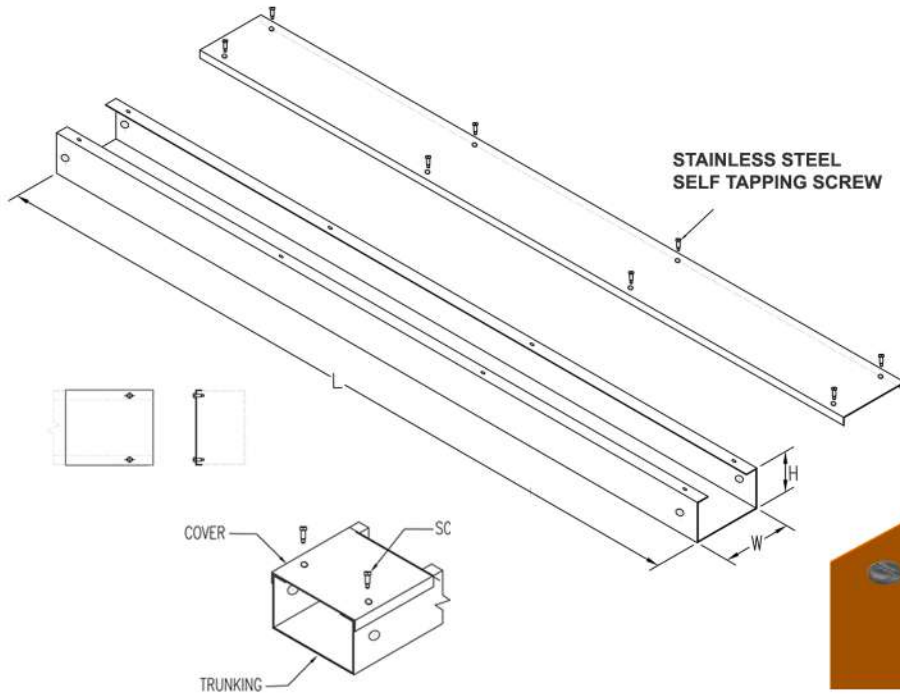

STANDARD SELF TAPPING SCREW COVER TRUNKING

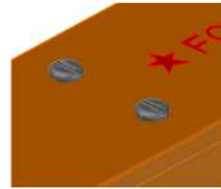

SPECIAL QUICK-RELEASE TURNBUCKLE TYPE COVER TRUNKING

*Units in MM
Other sizes available on request

MATERIAL & FINISHING:
STAINLESS STEEL TO AISI 304/316/316L

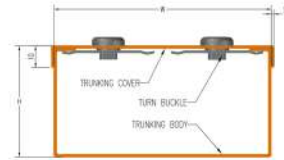

STANDARD SS FITTINGS

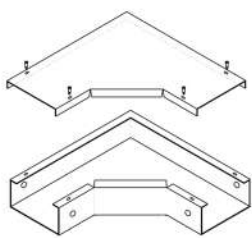

90 DEG HORIZONTAL FLAT ELBOW

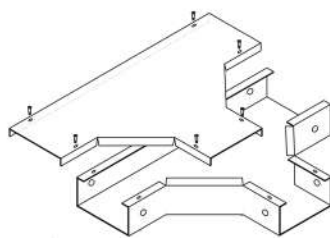

90 DEG HORIZONTAL TEE

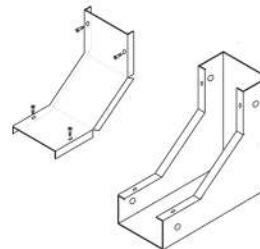

90 DEG VERTICAL INSIDE RISER

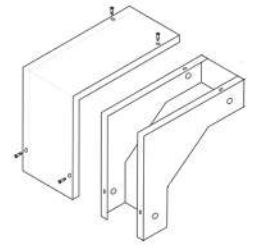

90 DEG VERTICAL OUTSIDE RISER

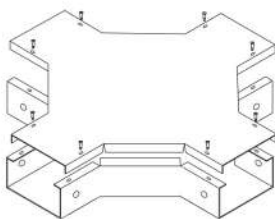

90 DEG HORIZONTAL CROSS

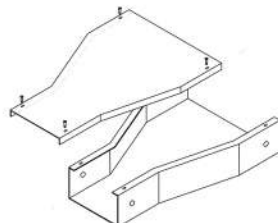

STRAIGHT REDUCER

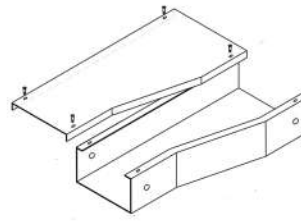

RIGHT HAND REDUCER

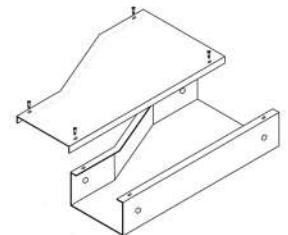

LEFT HAND REDUCER

REMARKS:
OTHER FITTING TYPES AVAILABLE UPON REQUEST
FULL DETAILS OF FITTING SPECIFICATIONS AVAILABLE UPON REQUEST

SMART^{Tr} SS CABLE CONTAINMENT

STRAIGHT CABLE TRAY (RF)

STANDARD RETURN FLANGE TYPE

STANDARD COMPLY TO
BS EN 61537

PRODUCT STANDARD LIST

WIDTH (W)	HEIGHT (H)	LENGTH (L)	THICKNESS (T)
150	50-100	2440-3000*	1.0-2.0
200	50-100	2440-3000*	1.0-2.0
300	50-100	2440-3000*	1.0-2.0
450	50-100	2440-3000*	1.0-2.0
500	50-100	2440-3000*	1.0-2.0
600	50-100	2440-3000*	1.0-2.0
750	50-100	2440-3000*	1.0-2.0
800	50-100	2440-3000*	1.0-2.0
900	50-100	2440-3000*	1.0-2.0
1000	50-100	2440-3000*	1.0-2.0

*Units in MM

Other sizes available on request

MATERIAL & FINISHING:

STAINLESS STEEL TO AISI 304/316/316L

REMARKS

OTHER PERFORATED HOLE DESIGNS
AVAILABLE UPON REQUEST

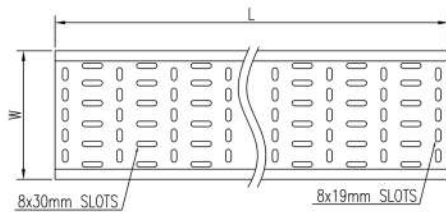
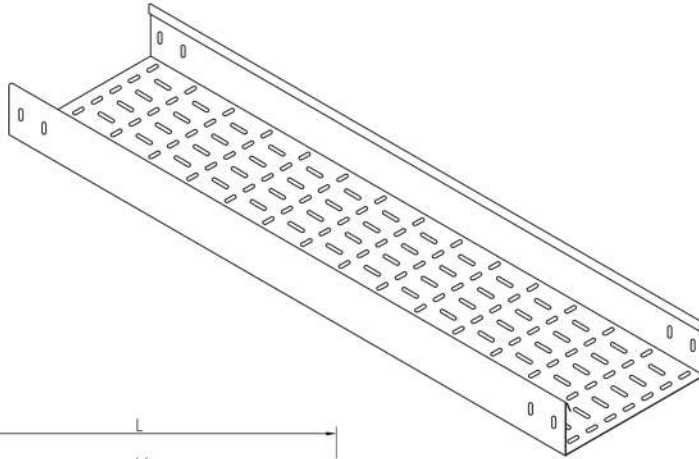

TOP VIEW

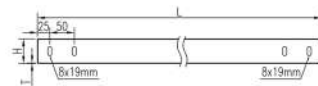

FRONT VIEW



SIDE VIEW

STANDARD SS FITTINGS

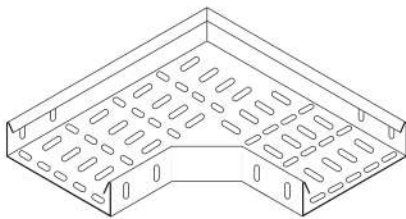

90 DEG HORIZONTAL FLAT ELBOW

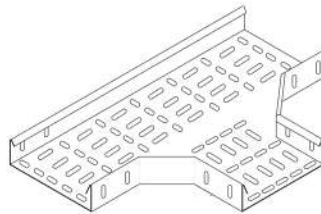

90 DEG HORIZONTAL EQUAL TEE

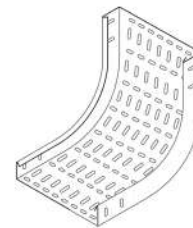

90 DEG HORIZONTAL
INSIDE RISER

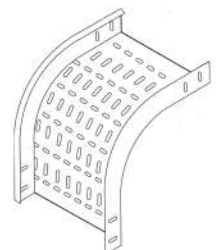

90 DEG HORIZONTAL
OUTSIDE RISER

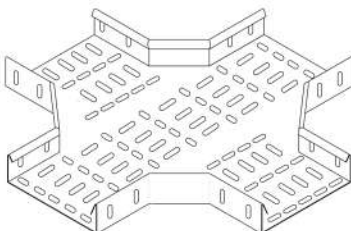

90 DEG HORIZONTAL
EQUAL CROSS

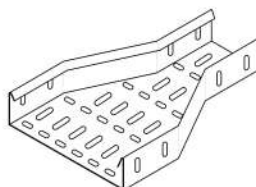

OFFSET
STRAIGHT REDUCER

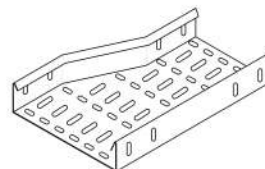

OFFSET
RIGHT HAND REDUCER

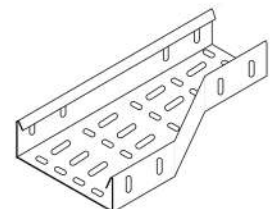

OFFSET
LEFT HAND REDUCER

REMARKS:

OTHER FITTING TYPES AVAILABLE UPON REQUEST
FULL DETAILS OF FITTING SPECIFICATIONS AVAILABLE UPON REQUEST

SMART^{tr} SS CABLE CONTAINMENT

STRAIGHT CABLE LADDER

INSIDE-RAIL KNOCK-DOWN TYPE

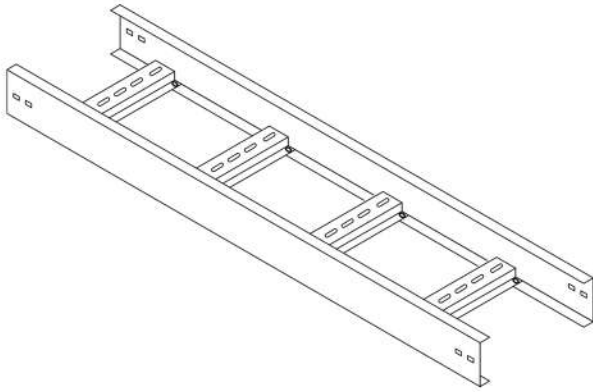

STANDARD COMPLY TO
BS EN 61537

PRODUCT STANDARD LIST

WIDTH (W)	HEIGHT (H)	LENGTH (L)	THICKNESS (T)
150	75-200	2440-3000*	1.5-2.0
200	75-200	2440-3000*	1.5-2.0
300	75-200	2440-3000*	1.5-2.0
450	75-200	2440-3000*	1.5-2.0
500	75-200	2440-3000*	2.0
600	75-200	2440-3000*	2.0
750	75-200	2440-3000*	2.0
800	75-200	2440-3000*	2.0
900	75-200	2440-3000*	2.0
1000	75-200	2440-3000*	2.0

*Units in MM
Other sizes available on request

MATERIAL & FINISHING:

STAINLESS STEEL TO AISI 304/316/316L

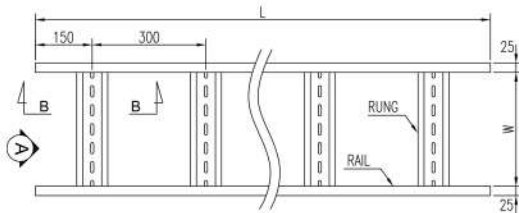

TOP VIEW

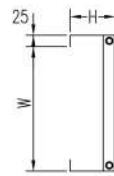

VIEW A
FRONT VIEW

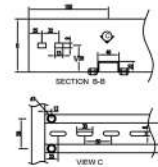

SIDE VIEW

STANDARD SS FITTINGS

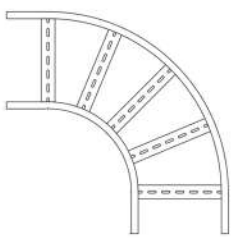

90 DEG HORIZONTAL FLAT ELBOW

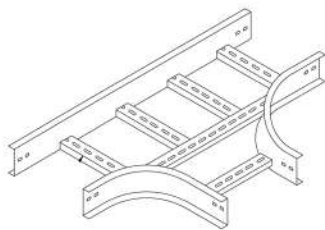

90 DEG HORIZONTAL EQUAL TEE

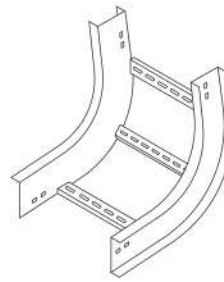

90 DEG VERTICAL
INSIDE RISER

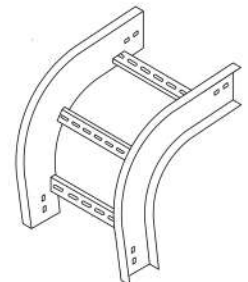

90 DEG VERTICAL
OUTSIDE RISER

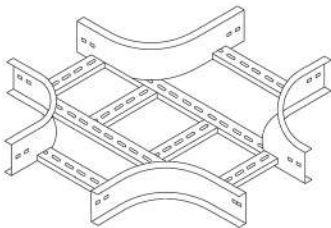

90 DEG HORIZONTAL EQUAL CROSS

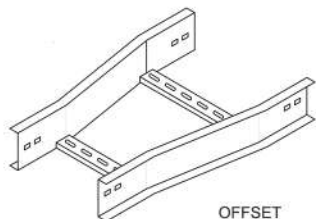

OFFSET
STRAIGHT REDUCER

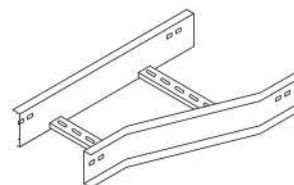

OFFSET
RIGHT HAND REDUCER

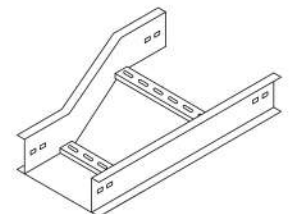

OFFSET
LEFT HAND REDUCER

REMARKS:
INSIDE-RAIL KNOCK-DOWN TYPE
OTHER FITTING TYPES AVAILABLE UPON REQUEST
FULL DETAILS OF FITTING SPECIFICATIONS AVAILABLE UPON REQUEST

STRUT CHANNELS

41 X 21

PART CODE
SS-4121-SS

41 X 41

PART CODE
SS-4141-SS

41 X 21 SLOTTED

PART CODE
SS-4121-SL-SS

41 X 41 SLOTTED

PART CODE
SS-4141-SL-SS

41 X 41 BACK TO BACK

PART CODE
SS-4141-BB-SS

STANDARD MATERIAL
STAINLESS STEEL 316/316L

STANDARD THICKNESS

2.0MM
(Above 2.0MM available upon request)

AVAILABLE LENGTH
3MTR/6MTR (STANDARD LGTH)

STANDARD FINISH

PLAIN STAINLESS STEEL

STANDARD COMPLY TO

BS 6946

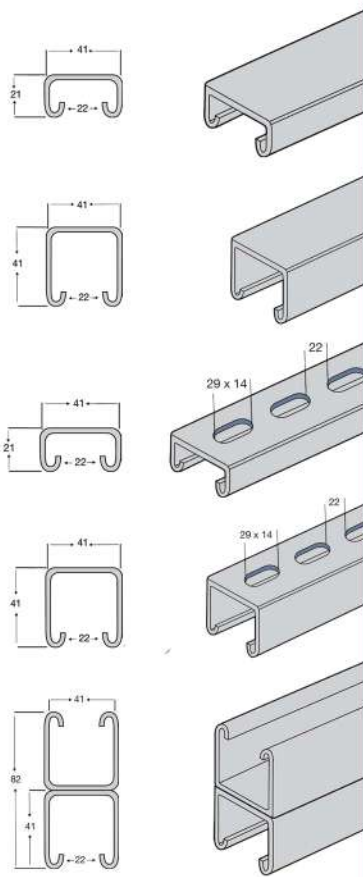

SS CHANNEL NUTS & HARDWARE

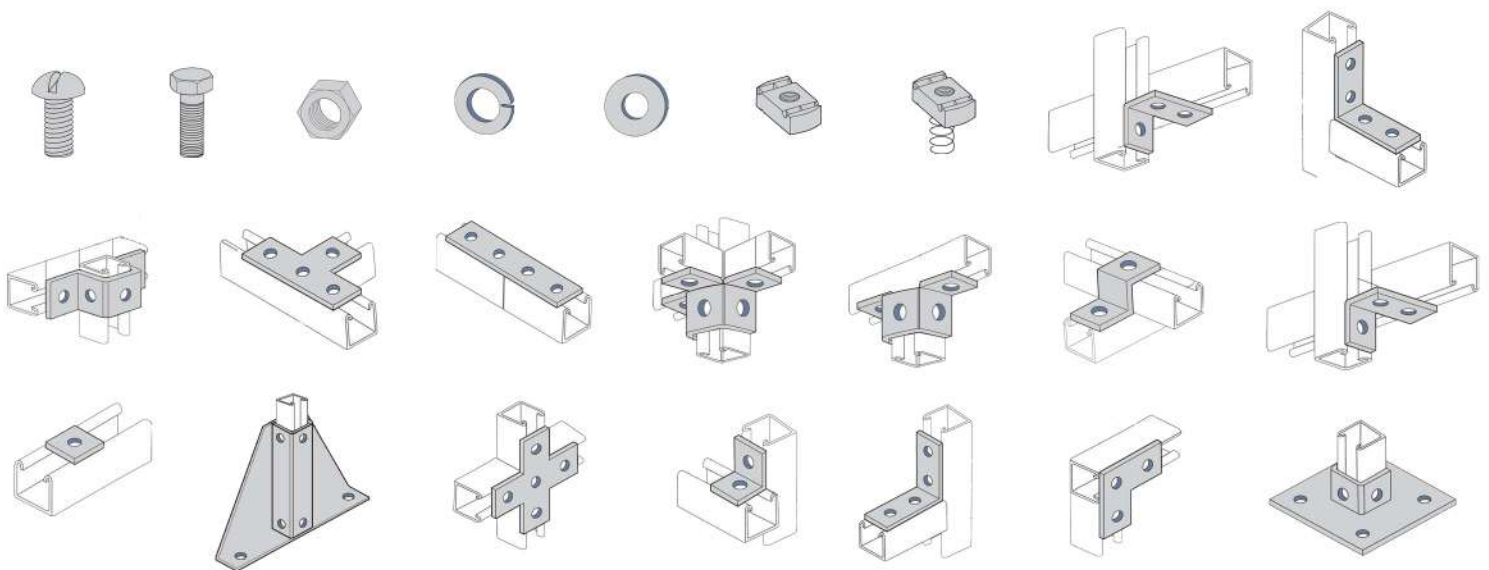

REMARKS: FITTING DIMENSIONS AVAILABLE ON REQUEST

SMART^{Tr} SS CABLE CONTAINMENT

SMARTr[®]

Your Trusted Partner in
Electrical & Mechanical Support

Copyright © 2022 SMARTr International Pte. Ltd. All content, graphics, images contained in this catalogue are protected by copyright laws and/or international treaties, and belong to SMARTr International Pte Ltd. These works, content, graphics or images may not be copied, reproduced or imitated whether in whole or in part, unless expressly permitted by SMARTr International Pte. Ltd.

All product dimensions and material specifications are as accurate as possible at time of print, SMARTr International Pte. Ltd reserves the right to make changes without notice.

The company makes every effort to ensure that the information provided in this catalogue is accurate. However, the company cannot guarantee this and accepts no liability for the use or interpretation of this data.